

vtech®

User's manual



LS1250-B

www.euphones.vtech.com

1. IMPORTANT SAFETY INSTRUCTIONS

When using your telephone equipment, basic safety precautions should always be followed to reduce the risk of fire, electric shock and injury, including the following:

1. Read and understand all the instructions.
2. Follow all warnings and instructions marked on the product.
3. Unplug this product from the wall outlet before cleaning. Do not use liquid cleaners or aerosol cleaners. Use a damp cloth for cleaning.
4. Do not use this product near water (for example, near a bath tub, kitchen sink, swimming pool).
5. Do not expose the telephone to direct sunlight or extreme cold environment. Do not put the telephone close to heating sources such as radiators, cookers, etc.
6. Do not overload wall outlets and extension cords as this can result in the risk of fire or electric shock.
7. Unplug this product from the wall outlet and refer servicing to VTech/
distributor under the following conditions:
 - When the power supply cord or plug is damaged or frayed.
 - If the product does not operate normally by following the operating instructions.
 - If the product has been dropped and the cabinet has been damaged.
 - If the product exhibits a distinct change in performance.
8. Avoid using a telephone (other than a cordless type) during an electrical storm. There may be a remote risk of electric shock from lightning.
9. Do not use the telephone to report a gas leak in the vicinity of the leak.
10. Use only the supplied NiMH (Nickel Metal Hydride) batteries! The operation periods for the handsets are only applicable with the default battery capacities.
11. The use of other battery types or non-rechargeable batteries/primary cells can be dangerous. These may cause interference and/or unit damages. The manufacturer will not be held liable for damage arising from such non-compliance.
12. Do not use third party charging bays. The batteries may be damaged.
13. Please note the correct polarity while inserting the batteries.
14. Battery should not be exposed to excessive heat such as bright sunshine or fire and immersed in water.

DISPOSAL WARNING

1. When this crossed-out wheeled bin symbol is attached to a product, it means the product is covered by the European Directive 2002/96/EC.
2. All electrical and electronic products/battery should be disposed of separately from the municipal waste stream via designated collection facilities appointed by the government or the local authorities.
3. The correct disposal of your old appliance/battery will help prevent potential negative consequences for the environment and human health.

For more detailed information about disposal of your old appliance/battery, please contact your city office, waste disposal service or the shop where you purchased the product.

If you have questions about this product, or having difficulty with setup or operation, contact our Customer Service Centre.

POWER ADAPTOR INFORMATION

Power adaptor Ten Pao International Ltd. - Model: S003IV0600045,
Input 100-240V AC 50/60Hz 150mA,
Output 6VDC 450mA (EU plug).

Battery Handset: NI-MH PACK x1, 2.4V, 750mAh
Doorbell: ALKALINE CELL, AAx2, 1.5V; 2800mAh

For pluggable equipment, the socket outlet shall be installed near the equipment and shall be easily accessible.

2. SET UP THE TELEPHONE

2.1 Package Contents

The package contains the following items:

- Telephone base and power adapter
- Handset (1 for IS7121A, 2 for IS7121-2A)
- Handset charger and charger adapter (1 for IS7121-2A)
- Doorbell with wall mount cover
- Telephone Wall mount bracket
- Battery compartment cover (1 for IS7121A, 2 for IS7121-2A)
- NiMH Rechargeable battery pack (1 for IS7121A, 2 for IS7121-2A)
- AA Alkaline batteries (2)
- Screw for doorbell (bottom)
- Screw for doorbell (wall mount)
- Wall anchors
- Double-sided adhesive tape
- Telephone line cord
- User's manual
- Warranty card

2.2 Connect the Base Station

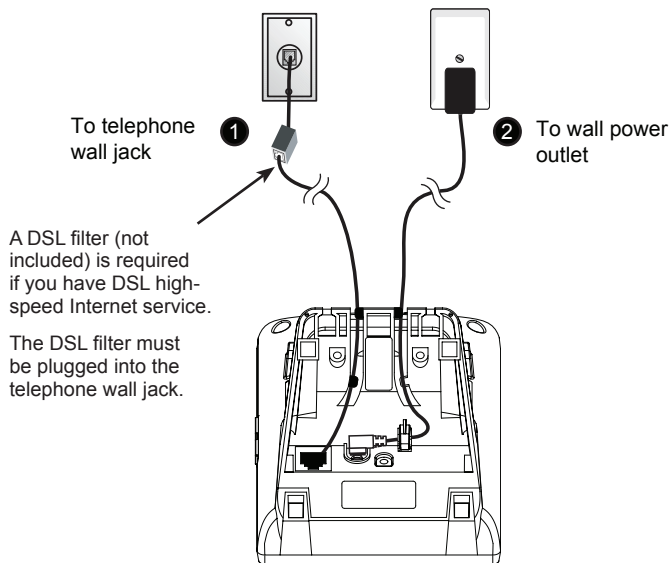

NOTE

- Use only the supplied power adapter.

2.3 Install and Charge the Handset Batteries

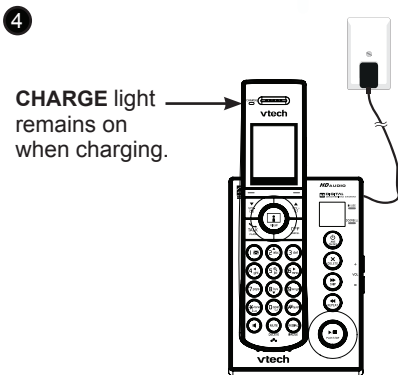
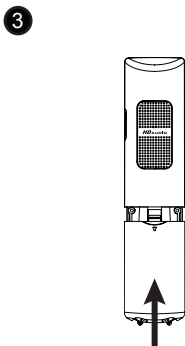
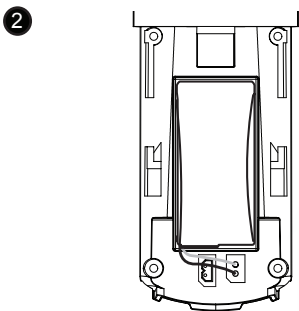
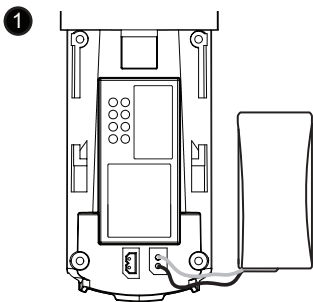

NOTES

- Use only the supplied NiMH rechargeable batteries.
- If you do not use the handset for a long time, disconnect and remove the batteries to prevent possible leakage.

2.4 Installation Options

Your telephone base is ready for tabletop use. If you want to mount your telephone on a wall, follow the steps below to connect the telephone base with a standard dual-stud telephone wall mounting plate. You may need a professional to install the wall mounting plate.

2.4.1 Tabletop to Wall Mount Installation

1. If you have already installed the telephone for tabletop use, unplug the telephone line cord from the telephone wall jack, and unplug the telephone base power adapter from the wall outlet. Remove the telephone line cord and the power adapter cord from the grooves.

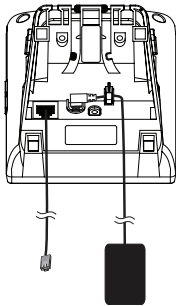

2. Route the telephone line cord through the rectangular hole on the wall mount bracket. Position the lower portion grooves on the telephone base to the lower portion tabs on the wall mount bracket. Make sure the upper portion grooves of the telephone base are above the upper portion tabs on the wall mount bracket. Push the telephone base down until it clicks securely in place.

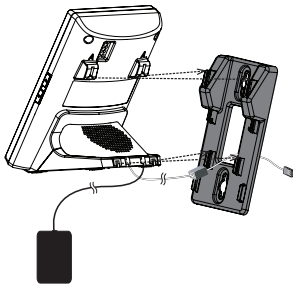

3. Plug the telephone line cord into the telephone wall jack or DSL filter. Align the holes on the bracket with the standard wall plate and slide the bracket down until it locks securely.

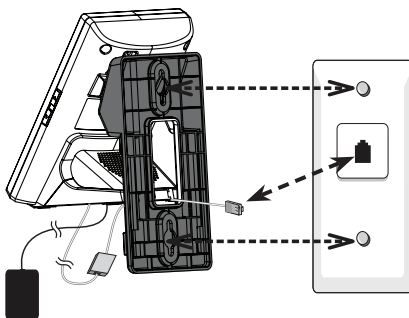

4. Plug the power cord into an electrical outlet not controlled by a wall switch. Bundle the telephone line cord and power adapter cord neatly with twist ties.

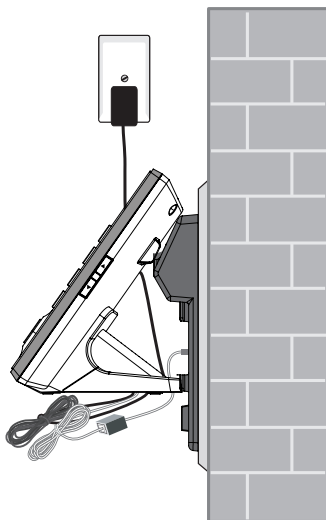

2.4.2 Wall Mount to Tabletop Installation

To change the telephone base from the wall mount position to tabletop position, follow the steps below.

1. If the telephone line cord and power adapter cord are bundled, untie them first.
2. Slide the wall mount bracket up and remove it from the wall plate. Unplug the telephone line cord (or DSL filter) from the wall. Unplug the power adapter from the power outlet.
3. Slide the telephone base up and remove it from the wall mount bracket.
4. See section **Connect the Base Station**.

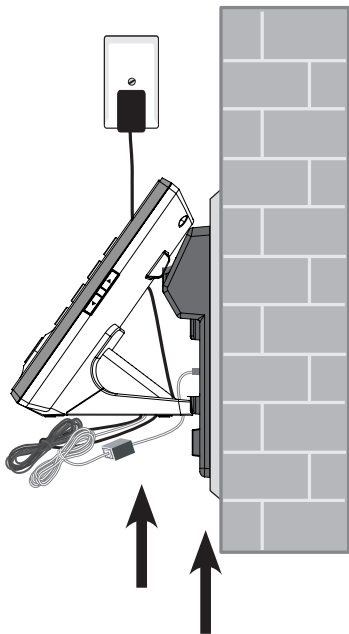

2.5 Doorbell Battery Installation

1. Remove the wall mount cover at the back.
2. Install two AA batteries into the battery compartment, matching the polarity markings (+ and -) inside the battery compartment.

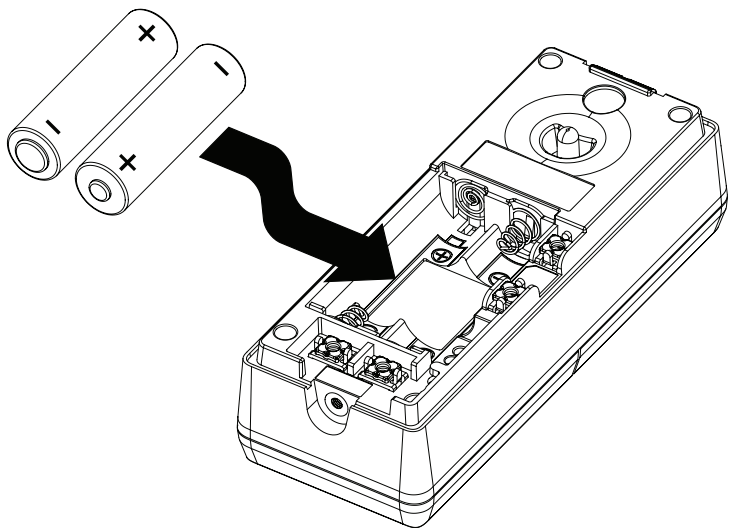





2.6 Locating the Doorbell

Before mounting the doorbell on a wall, make sure you test if the location you install the doorbell is in range, and adjust the camera angle to best suit your needs.

To test the location for installation:

Hold the doorbell in the location where you want to install the doorbell, then follow the steps below to test the reception range and video capture angle.

1. Press **MENU** → ▲/▼ → **Settings** → **SELECT**.
2. Press ▲/▼ → **Doorbell setup** → **SELECT**.
3. Press /**DOORBELL** → check video streaming quality.
4. Press **NEXT**.
5. Press **ISO** → **+ / -** → adjust video streaming brightness.
 - If audio feedback occurs, press  on the handset to turn off the speakerphone.
 - If the desired location is in good range, the handset displays .
 - If the desired location is not in good range, the handset flashes  in red. Press **INFO** for instructions to relocate your handset and/or telephone base. When the reception is in good range, the handset displays . Press **OK** to return to the video streaming.
6. Keep the video streaming on for camera lens adjustment.

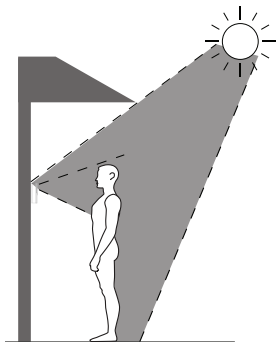

When finding a desirable location for the doorbell:

- Make sure the visitor is standing in a reasonable distance away from the doorbell.
- Avoid mounting it on a location which is subjected to vibration or shock.
- Avoid mounting it on an enclosed area where it may cause echoes.
- Avoid mounting it to where it is exposed to direct sunlight.

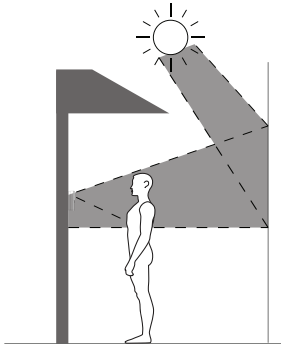

- Avoid mounting it to where reflections may be caused by sunlight, for example, opposite to a white wall.
- Two built-in infrared LEDs are for night vision. Make sure the surrounding light source is sufficient for infrared operation.

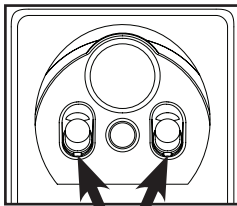

Infrared LEDs

Test at the front door to determine when the infrared LEDs turn on. When they are in operation, they turn red.

To adjust the shooting area, you may either relocate the doorbell in different height level, or adjust the camera angle (see below).

To adjust the camera angle:

- Tilt the lever to adjust the angle of the camera lens. The camera lens can be adjusted to left, right or down, up to 10 degrees.

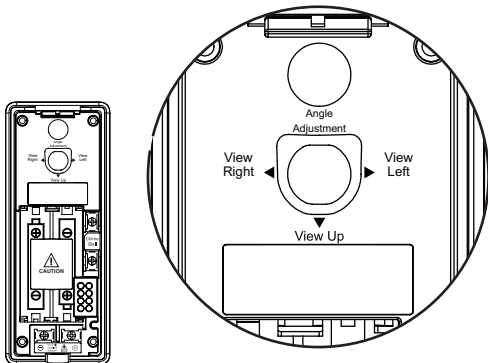

The diagrams below demonstrate an example of doorbell camera position to view a visitor about 20 inches from the camera. The camera in this example is set in default angle (0 degree).

You may move the lever at the back of the doorbell to adjust the shooting area (the camera lens).

Side view

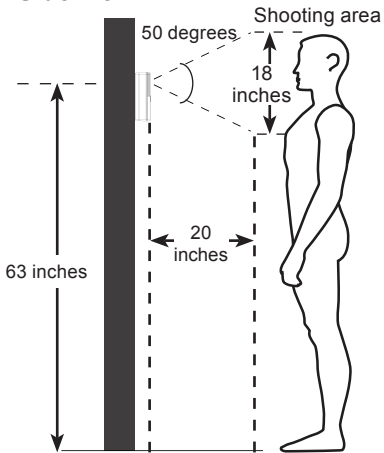

Top view

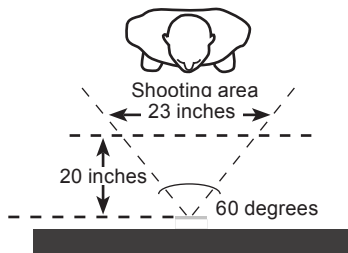

You may install the doorbell in a lower position. The diagram below demonstrates an example of doorbell camera position to view a visitor about 20 inches from the camera. The camera in this example is set in 10 degrees angle upward.

Side view

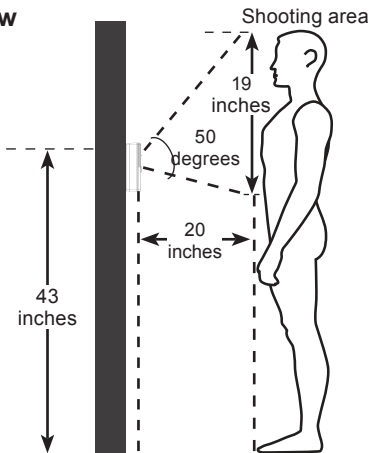

You may install the doorbell on the left or right side. The diagram below demonstrates an example of doorbell camera position to view a visitor about 20 inches from the camera. The camera in this example is set in 10 degrees angle to the right.

Top view

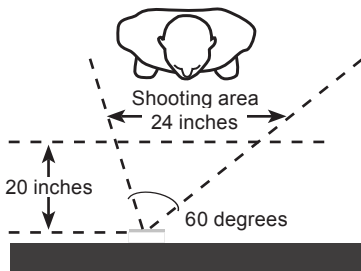

After you have tested the reception range and found the desirable location to install the doorbell, press **END** on the handset to end the video streaming and proceed to **Install the Doorbell Wall Mount Cover** and **Install the Doorbell**.

2.7 Install the Doorbell Wall Mount Cover

Make sure to test the reception and the doorbell position before you mount the doorbell on the wall. See **Locating the doorbell** to choose a desirable position for the doorbell.

1. Use a pencil to mark two holes on the desired location. Then remove the wall mount and drill two holes in the wall. Check for reception strength and camera angle before drilling the holes.

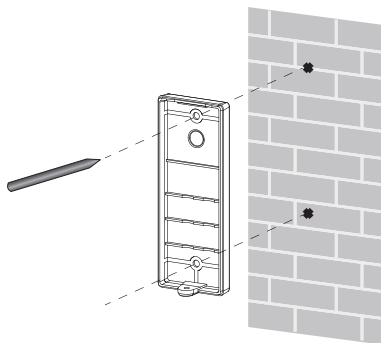

2. Place the wall anchors into the holes, and tap gently on the ends with a hammer, until the wall anchors are flush with the wall.



3. Align the holes on the wall mount cover with the holes on the wall (or stud).
Tighten the screws into the holes to secure the wall mount cover onto the wall.

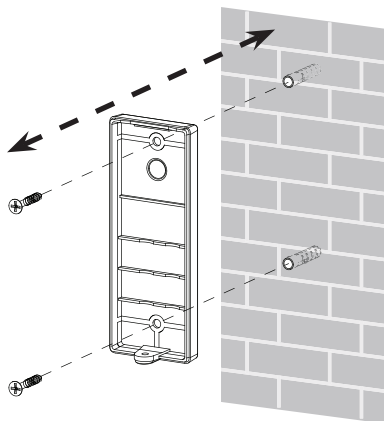

2.8 Install the Doorbell

1. Push the doorbell gently onto the wall mount until they are sealed tightly.
This doorbell meets the IPX4 waterproof standard. Make sure the doorbell is tightly sealed with its wall mount cover in order to maintain its waterproof ability.

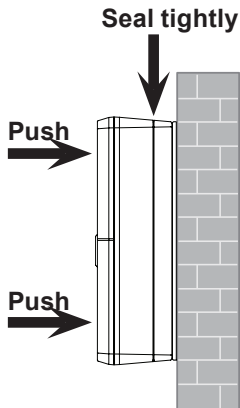

2. Tighten the screw into the threaded socket at the bottom to secure.

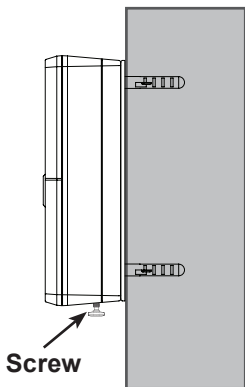

2.9 Detach Doorbell From Wall Mount Cover

After an extended exposure to cold, heat or humidity, the doorbell gasket rubber may become sticky.

If you need to remove the doorbell from its wall mount cover in case of battery replacement or doorbell relocation, follow the steps below.

1. Remove the screw at the bottom.
2. Insert a flat-bladed screwdriver between the doorbell and its wall mount cover to pry open at both sides.

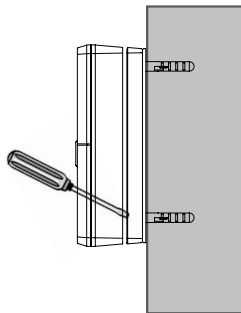
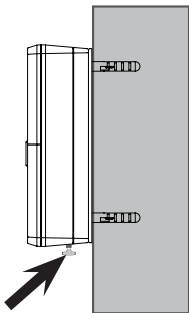

3. Pry the doorbell off.

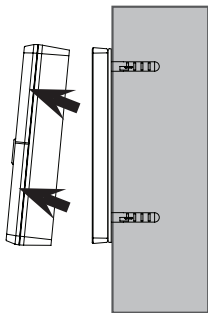

3. GET TO KNOW YOUR PHONE

3.1 Overview of the Handset

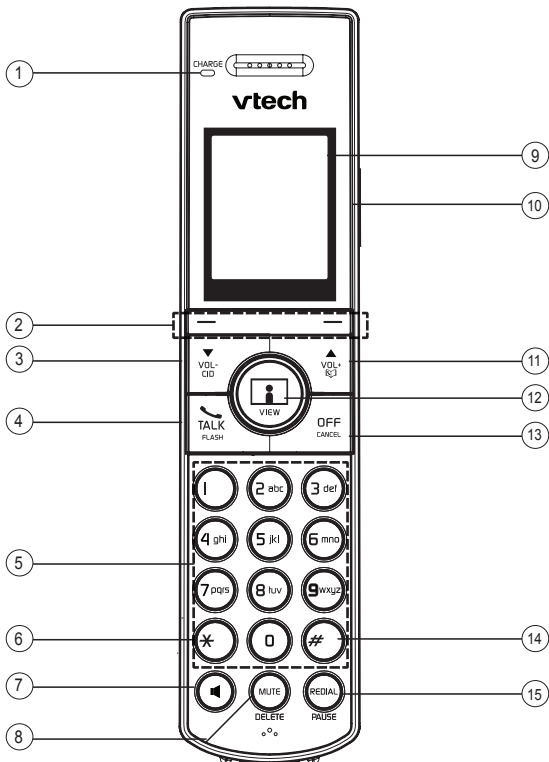

1. CHARGE light

On when the handset is charging in the telephone base.

2. Soft keys (2)

Press to select a menu item displayed above the key.

3. /VOL-/CID

Press to scroll down while in a menu, or in the directory, caller ID log or redial list.

Press to review the caller ID log when the phone is not in use.

While entering names or numbers, press to move the cursor to the left.

During a call or message playback, press to decrease the listening volume.

4. /FLASH

Press to make or answer a call.

During a call, press to answer an incoming home call when you receive a call waiting alert.

5. Dialing keys

Press to enter numbers or characters.

Press to answer an incoming call.

6.

During a call, press to switch to tone dialing if you have pulse service.

7.

Press to make or answer a call using the handset speakerphone.

Press to switch between the handset speakerphone and the handset earpiece during a call.

While entering or editing a directory entry: Press to erase a digit or character.

While the handset is ringing: Press to silence the ringer temporarily.

During message or outgoing message playback: Press to delete a message or outgoing message.

8. MUTE/DELETE

During a call, press to mute the microphone.

While the phone is ringing, press to silence the handset ringer temporarily.

While reviewing the redial list, directory or caller ID log, press to delete an individual entry.

While using the dialing keys, press to delete digits, or press and hold to return to idle mode.

9. LCD display

10. SNAPSHOT

Press to take a photo shot of visitor from the doorbell during video streaming.

11. ▲/VOL+/

Press to scroll up while in a menu, or in the directory, caller ID log or redial list.

Press to review the directory when the phone is not in use.

While entering names or numbers, press to move the cursor to the right.

During a call or message playback, press to increase the listening volume.

12. /VIEW

When you hear a chime, press to start video streaming.

Press to extend video streaming session.

13. OFF/CANCEL

During a call, press to hang up.

While in a menu, press to return to the previous menu, or press and hold to return to idle mode, without making changes.

While the phone is ringing, press to silence the handset ringer temporarily.

Press and hold to erase the missed call indicator when the phone is not in use.

14.

Press repeatedly to display other dialing options while reviewing a caller ID log entry.

15. REDIAL/PAUSE

Press repeatedly to view the last 10 numbers dialed.

While entering numbers, press and hold to insert a dialing pause.

3.2 Overview of the Base Station

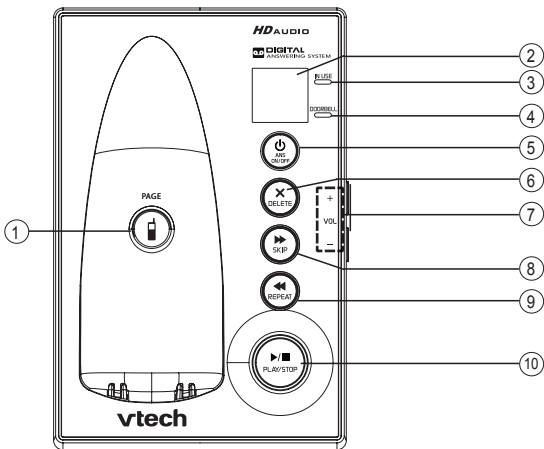

- 1. /PAGE**
Press to page all system handsets.
- 2. Message window**
Shows the number of messages, and other information of the answering system or telephone base.
- 3. IN USE light**
Flashes quickly when there is an incoming call.
Flashes when another telephone sharing the same line is in use.
On when the telephone line is in use.
- 4. DOORBELL light**
On when a doorbell is in a video streaming session.
Flashes quickly when the doorbell is being pressed.
- 5. /ANS ON/OFF**
Press to turn the answering system on or off.

6. X/DELETE

Press to delete the playing message.
Press twice to delete all old messages when in idle.

7. +/VOL/-

Press to adjust the listening volume during a call or message playback.
Press to adjust the telephone base ringer volume when the phone is not in use.

8. ►/SKIP

Press to skip to the next message.

9. ◀/REPEAT

Press to repeat the playing message.
Press twice to play the previous message.

10. ►/■/PLAY/STOP

Press to play messages
Press to stop playing messages.

3.3 Overview of the Doorbell

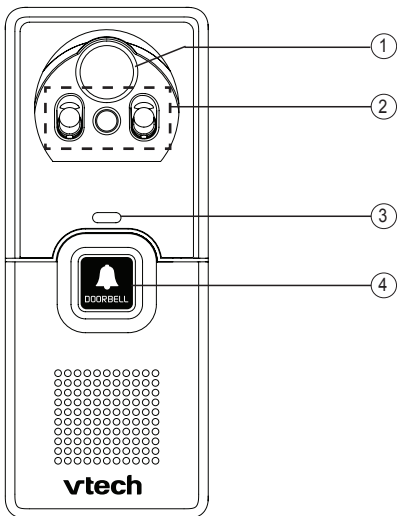

1. Camera lens

2. Infrared LEDs

Backup light for night vision.

3. Doorbell light













Flashes when  DOORBELL is pressed.

4.  DOORBELL

Press to send a chime to the telephone base and capture a photo.

3.4 Handset LCD Display Icons and Symbols

The screen display gives you information on the current status of the telephone.

Display icons	Description: Icons can be on (visible), or Flashing or Off (not visible)
	Battery is low; place handset in charger to recharge.
	Full battery power level.
	2/3 battery power level.
	1/3 battery power level.
	High level of video signal reception strength.
	Medium level of video signal reception strength.
	Low level of video signal reception strength.
	The handset speakerphone in use.
	On if the doorbell is ringing.
	On steadily if the handset ringers are turned off.
	There are new message recorded by the answering machine.
	There are new voicemail received from the telephone service provider.
MIC OFF	Microphone is muted.
ANS ON	The answering machine is turned on.

3.5 Handset Menu Structure

In idle mode, press MENU to enter the menu. Refer to the following table for the menu structure.

Key Press MENU \longleftrightarrow $\blacktriangle/\blacktriangledown$ \longleftrightarrow $\blacktriangle/\blacktriangledown$ \longleftrightarrow $\blacktriangle/\blacktriangledown$

Main Menu	Play msgs	AnsweringSys	Directory
Sub menu	Play new messages Play old messages	Announcement Delete all old Record memo Answer ON/OFF Ans sys setup	Review Add contact Speed dial

$\blacktriangle/\blacktriangledown$ \longleftrightarrow $\blacktriangle/\blacktriangledown$ \longleftrightarrow $\blacktriangle/\blacktriangledown$ \longleftrightarrow $\blacktriangle/\blacktriangledown$

Caller ID log	Photo log	Ringers	Chime
View Del all calls	View/Doorbell X Delete all	Ringer volume Ringer tone	Chime volume Chime tone

$\blacktriangle/\blacktriangledown$ \longleftrightarrow $\blacktriangle/\blacktriangledown$

Date & Time	Settings
	LCD language Rename devices LCD brightness Dim mode Wallpaper Voicemail # Clr voicemail Key tone Dial mode Flash time Call divert Doorbell setup

4. PHONE SETTINGS

4.1 Handset Ringer Volume

You can set the ringer volume or turn the ringer off on each handset. When the ringer is off, the handset displays .

1. Press **MENU** → ▲/▼ → **Ringers**
2. Press **SELECT** → **Ringer volume**
3. Press **SELECT** → ▲/▼ → (The desired volume level).
4. Press **SET**.

-OR-

Press **OFF** → turn off the ringer → **SET**.

NOTE

The ringer volume also determines the ringer volume for intercom calls. When the ringer is set to off, that handset is silenced for all incoming calls except paging tone.

4.2 Telephone Base Ringer Volume

Press **+VOL / VOL-** on the right side of telephone base – adjust the ringer volume when the telephone base is not in use.

When you set the ringer volume to silent, the base ringer is off and the system announces, *“Base ringer is off.”*

4.3 Ringer tone

You can choose from different ringer tones for each handset.

1. Press **MENU** → ▲/▼ → **Ringers**
2. Press **SELECT** → ▲/▼ → **Ringer tone,**
3. Press **SELECT** → ▲/▼ → (The desired ringer tone).
4. Press **SELECT**.

NOTE

If you turn off the ringer volume, you will not hear ringer tone samples.

4.4 Chime Volume

You can adjust the telephone base or handset chime volume level, or turn the chime off.

1. Press **MENU** → ▲/▼ → **Chime**.
2. Press **SELECT** → **Chime volume**
3. Press **SELECT** → ▲/▼ → **Local handset / Base**
4. Press **SELECT** → ▲/▼ → (The desired volume level).
5. Press **SET**.

-OR-

Press **OFF** → turn off the chime → **SET**.

4.5 Chime Tone

You can choose from different chime tones for the telephone base or handset.

1. Press **MENU** → ▲/▼ → **Chime**.
2. Press **SELECT** → ▲/▼ → **Chime tone**.
3. Press **SELECT** → ▲/▼ → **Local handset / Base**
4. Press **SELECT** → ▲/▼ → (The desired chime tone).
5. Press **SET**.

4.6 Quiet Mode

You can turn on the quiet mode for a period of time (1-12 hours). During this period, all tones (except paging tone and chime), Caller ID Announce and call screening are muted.

When you turn on the quiet mode, the answering system turns on automatically. When the quiet mode duration expires, the answering system remains on.

To set the quiet mode duration:

1. Press and hold **#**.
2. Press ▲/▼ → (The desired duration).
3. Press **SET**.

The handset displays **Answering system and chime tone is ON during quiet mode** and then returns to idle. The handset displays **ANS ON**,  and **quiet**.

To turn off the quiet mode:

Press and hold **#**.

The handset displays **Quiet mode is OFF** briefly. You hear a confirmation tone and the handset returns to idle.

NOTE

If you change the settings of the ringer tone, handset ringer volume or telephone base ringer volume while the quiet mode is on, you can still hear the samples of them.

4.7 Set Date and Time

The answering system announces the date and time of each message prior to playing it. Before using the answering system, set the date and time as follows.

1. Press **MENU** → ▲/▼ → **Date & Time**
2. Press **SELECT** → ▲/▼ → Enter the month, date & year.
3. Press **SET** → ▲/▼ → Enter the hour & minute.
4. Press **SET**.

NOTES

- If the date and time are not set when a message is recorded, the system announces, "Time and date not set," before each message plays.
- The telephone plays two beeps if you enter an invalid number.

4.8 LCD language

You can choose your desired language to be displayed on LCD.

1. Press **MENU** → ▲/▼ → **Settings**
2. Press **SELECT** → **LCD language**.
3. Press **SELECT** → ▲/▼ → (The desired language).
4. Press **SET**.
5. Press **YES**.

4.9 Rename Devices

You can create a name for each handset and doorbell. The new name can be up to 11 characters.

1. Press **MENU** → ▲/▼ → **Settings**
2. Press **SELECT** → ▲/▼ → **Rename devices.**
3. Press **SELECT** → ▲/▼ → **Local handset / Doorbell**
4. Press **SELECT**.
5. Use the dialing keys to edit the name
 - Press **DELETE** / **BACKSP** → erase a character.
 - Press and hold **DELETE** → erase all characters.
 - Press ▲/▼ → move the cursor to the right or to the left.
6. Press **SAVE**.

4.10 LCD Brightness

You can adjust the screen brightness of your handset to optimize readability lighting conditions.

1. Press **MENU** → ▲/▼ → **Settings**
2. Press **SELECT** → ▲/▼ → **LCD brightness.**
3. Press **SELECT** → ▲/▼ → (The desired brightness level).
4. Press **SET**.

4.11 Dim Mode

You can set the handset backlight in dim mode or completely off when it is not in use.

1. Press **MENU** → ▲/▼ → **Settings**
2. Press **SELECT** → ▲/▼ → **Dim mode.**
3. Press **SELECT** → ▲/▼ → **On / Off.**
4. Press **SET**.

4.12 Wall Paper

You can set the wallpaper for your handset.

1. Press **MENU** → ▲/▼ → **Settings**
2. Press **SELECT** → ▲/▼ → **Wallpaper**.
3. Press **SELECT** → ▲/▼ → (The desired each wallpaper).
4. Press **SET**.

4.13 Clear Voicemail Indicators

If you subscribe to voicemail service offered by your telephone service provider, **New voicemail** and  display on the handset when you have new voicemail messages. Contact your telephone service provider for more information and assistance about using your voicemail service.

After you have listened to all new voicemail messages, the indicators on the handset turn off automatically.

Use the clear voicemail feature when the telephone indicates that there is new voicemail but there are none (for example, when you have accessed your voicemail while away from home). Clearing the voicemail waiting indicator only turns off the indicators; it does not delete your voicemail messages. As long as you have new voicemail messages, your telephone service provider continues to send the signal to turn on the indicators.

To manually turn off the new voicemail indicators:

1. Press **MENU** → ▲/▼ → **Settings**
2. Press **SELECT** → ▲/▼ → **Clr voicemail**
3. Press **SELECT**.
4. Press **YES**.

NOTE

Your telephone service provider may alert you of new messages with a stutter (broken) dial tone. Contact your telephone service provider for details.

4.14 Key Tone

You can adjust the volume level of key tone, or turn it off for each handset. If you turn the key tone off, there are no beeps when you press the handset keys.

1. Press **MENU** → ▲/▼ → **Settings**
2. Press **SELECT** → ▲/▼ → **Key tone**.
3. Press **SELECT** → ▲/▼ → (The desired volume level).
4. Press **SET**.

4.15 Dial Mode

The dial mode settings is country dependent. Please contact your local service provider for the correct settings.

1. Press **MENU** → ▲/▼ → **Settings**
2. Press **SELECT** → ▲/▼ → **Dial Mode**.
3. Press **SELECT** → ▲/▼ → (The desired dial mode).
4. Press **SET**.

4.16 Flash Time

The flash time settings is country dependent. Please contact your local service provider for the correct settings.

1. Press **MENU** → ▲/▼ → **Settings**
2. Press **SELECT** → ▲/▼ → **Flash Time**.
3. Press **SELECT** → ▲/▼ → (The desired flash time).
4. Press **SET**.

4.17 Call Divert

You can divert a doorbell call to an external number. The telephone base will call directly to the destination number during doorbell ringing.

To set call divert on:

1. Press **MENU** → ▲/▼ → **Settings**
2. Press **SELECT** → ▲/▼ → **Call divert**.
3. Press **SELECT** → ▲/▼ → **On**.
4. Press **SET** → Enter destination number.

5. Press **NEXT** → Enter the PIN (default: **0000**).
 - If destination number has been set before, the screen displays the current destination number. You can press **CLEAR** to clear the current number and enter a new destination number, then press **NEXT**.
6. Press **SAVE**.

To set call divert off:

1. Press **MENU** → ▲/▼ → **Settings**
2. Press **SELECT** → ▲/▼ → **Call divert**.
3. Press ▲/▼ → **Off**.
4. Press **SET**.

-OR-

Press and hold ***** to set call divert off when the telephone is not in use. The screen displays **Call divert OFF**. You hear a confirmation tone and the call divert icon disappears.

5. USING THE DOORBELL

5.1 Answer a Chime

When  **DOORBELL** is pressed, you hear a chime. The doorbell automatically captures a photo of the visitor.

- Press **SPEAK** → Answer the chime.

NOTES

- Only one handset can answer the chime and start a video streaming session.
- If you have more than two handsets, only the first two registered handsets display the photo.
- The video streaming ends after 30 seconds.
- Press **OFF** to silence the chime.
- Only one doorbell can perform video streaming session at a time. If other doorbell is pressed, you hear a chime, but no handsets can answer.

When call divert is set to on:



Only the telephone base plays a chime tone and the handsets display **Call divert is in progress**. The telephone base calls to the destination number. For call divert setting, see **Call Divert** section.

- Enter the PIN on the destination phone → Answer the doorbell call.
- Press **OFF** / **✖** – End the doorbell call.

NOTES

- If you do not press **OFF** or **✖** to end the doorbell call. busy tone will be heard on the doorbell side.
- When the screen displays the **Call divert is in progress** message, other messages such as **xx Missed calls** will be hidden.

5.2 Start a Video Streaming Session

- When  **DOORBELL** is pressed and you hear a chime on the handset, press  /**VIEW** / **VIEW**.

NOTES

- If you do not press the flashing **SPEAK** during the video streaming, the session ends in 2 minutes.

-OR-

- Press  /**VIEW** when the handset is not in use

NOTE

- If you have more than one doorbell, press ▲/▼ to scroll to the desired doorbell and then press **SELECT**.



-OR-

- Press  /**VIEW** during a call. The call is put on hold and other system handsets display **Line on hold**. You hear a beep every 10 seconds.

NOTE

- If you do not press the flashing **SPEAK** during the video streaming, the session ends in 2 minutes.

Options while video streaming:

- Press the flashing **SPEAK** → talk to the visitor.
- Press **SNAPSHOT** – take a photo shot of the visitor.
- Press **ISO** →  /  – adjust the video stream brightness.

NOTE

After you press **SPEAK** to start a conversation with the visitor, the video/audio streaming session ends in 45 seconds if it is initiated by the doorbell or 60 seconds if initiated by the handset.

5.3 Extend a Video Streaming Session

The video/audio streaming session ends in 45 seconds if it is initiated by the doorbell or 60 seconds if initiated by the handset. When the screen displays **Session is ending... Press [VIEW] to extend.** and **[VIEW] /VIEW** flashes, you have five seconds to extend the video session,

Press **[VIEW] /VIEW** – extend the video session.

- If you did not press **SPEAK** during the video session, the video streaming extends for 30 seconds if it is initiated by the doorbell, or for 120 seconds if initiated by the handset.
- If you pressed **SPEAK** during the video session, the video streaming extends for 45 seconds if it is initiated by the doorbell, or for 60 seconds if initiated by the handset.

5.4 End a Video Streaming Session

- Press **OFF**.
- OR-**
- Place the handset back in the telephone base.

5.5 Answer an Incoming Call During Video Streaming

If you receive an outside call during a video streaming session, there is an alert tone.

- To answer the outside call, press **TALK** on the handset. The video streaming session ends automatically.
- To end the video streaming session without answering the outside call, press **OFF**. The video streaming session ends and the telephone continues to ring.

5.6 View Captured Photos

The telephone stores up to 100 photos captured by the doorbell.

1. Press **[VIEW] /VIEW**.
2. Press **SELECT** → **▲/▼** → browse through the photo log.

5.7 Delete a Captured Photo

- When the desired photo displays, press **DELETE**.

5.8 Delete All Captured Photos

1. Press **VIEW**.
2. Press **▲/▼** → **Delete all**
3. Press **SELECT**.
4. Press **YES**.

5.9 Night Vision

To help you carry out the video streaming session at night, the doorbell automatically uses the light from its infrared LEDs for transmitting images to the handset unit when the surrounding is dark. However, it only transmit black-and-white images.

6. USING THE PHONE

6.1 Make a Call

1. Enter telephone number.
2. Press  / .

6.2 Answer a Call

Press  /  / any dialing key (**0-9**, ***** or **#**).

6.3 End a Call

Press **OFF**.

-OR-



Place the handset back in the telephone base.

6.4 Handsfree

During a call, press  on the handset to switch between the speakerphone and normal handset use.

6.5 Volume Control

During a call:

Press  / **VOL-** /  / **VOL+** – adjust the listening volume.

NOTES

- The handset earpiece and speakerphone volume settings are independent.
- When the volume reaches the minimum or maximum setting, you hear two beeps.



6.6 Mute

The mute function allows you to hear the other party but the other party cannot hear you.

- During a call, press **MUTE** on the handset. The screen briefly displays **Microphone off**, then displays **MIC OFF** until the mute function is turned off.
- Press **MUTE** on the handset to resume the conversation. The screen briefly displays **Microphone on**.

6.7 Call Waiting

If you subscribe to call waiting service from your telephone service provider, you hear a tone if someone calls while you are already on a call.

- Press  **FLASH** – put the current call on hold and take the new call.
- Press  **FLASH** – switch back and forth between calls.

6.8 Temporary Ringer Silencing

When the telephone is ringing, you can temporarily silence the ringer of the handset or the telephone base without disconnecting the call. The next call rings normally at the preset volume.

To silence the handset ringer:

- Press **CANCEL**, **MUTE** or **SILENCE** on the handset, the handset displays **Ringer muted** briefly then  displays.

To silence the telephone base ringer:

- Press **VOL-** on the telephone base.
- The handset and the telephone base ring when there is an incoming call unless the ringer volume setting on that device is turned off.

6.9 Temporary Tone Dialing

If you have pulse (rotary) service only, you can switch from pulse to touch-tone dialing temporarily during a call. This is useful if you need to send touch-tone signals to access your telephone banking or long distance services.

1. During a call, press ***** on the handset.
2. Use the dialing keys to enter the number you wish to dial. The telephone sends touch-tone signals. It automatically returns to pulse dialing mode after you end the call.

6.10 Chain Dialing

Use this feature to initiate a dialing sequence from numbers stored in the directory, caller ID log or redial list while you are on a call using the handset.

Chain dialing can be useful if you wish to access other numbers (such as bank account numbers or access codes) from the directory, caller ID log or redial list.

To access a number from the directory while on a call with the handset:

1. Press **OPTION** → **Directory**.
2. Press **SELECT** → **▲/▼** → (The desired entry).
3. Press **DIAL**.

To access a number from the caller ID log while on a call with the handset:

1. Press **OPTION**.
2. Press **▲/▼** → **Caller ID log**
3. Press **SELECT** → **▲/▼** → (The desired entry).
4. Press **DIAL**.

To access a number from the redial list while on a call with the handset:

1. Press **REDIAL**.
2. Press **▲/▼** → (The desired entry).
3. Press **DIAL**.

NOTE

Press **CANCEL** to exit the directory, caller ID log or redial list when you are on a call.



6.11 Find Handset

This feature helps you find the misplaced handset(s).

To start the paging tone:

- Press /PAGE on the telephone base. All idle handsets ring and their screens display **** Paging ****.

To stop the paging tone:

- Press /PAGE on the telephone base.
-OR-
- Press  TALK, , **CANCEL** or any dialing key (**0-9**, ***** or **#**) on a handset.
-OR-
- Place the handset in the telephone base.

NOTE

Press **MUTE** or **SILENCE** to turn off the ringer of that handset. Its screen briefly shows **Ringer muted** and displays .



6.12 Redial

Each handset stores the last 10 telephone numbers dialed (up to 30 digits). When there are already 10 entries, the oldest entry is deleted to make room for the new entry.

To review and dial a redial number:

1. Press **REDIAL**.
2. Press /▼ → (The desired entry).
3. Press  TALK / .

-OR-

1. Press  TALK / .
2. Press **REDIAL**.
3. Press /▼ → (The desired entry).
4. Press **DIAL**.

To delete a redial number:

1. Press **REDIAL**.
2. Press **▲/▼** → (The desired entry).
3. Press **DELETE**.

6.13 Equalizer

The equalizer feature on the handset enables you to change the quality of the handset audio to best suit your hearing. While on an outside call or an intercom, press **EQ** repeatedly to select the equalizer setting **Treble 1**, **Treble 2**, **Bass** or **Natural** (the default setting) for the handset.

NOTE

The current equalizer setting remains unchanged until a new setting is selected.

7. DIRECTORY

The home directory stores up to 50 entries with up to 30 digits for each phone number and 15 characters for each name.

7.1 Create a New Entry in the Directory

1. Press **MENU** → ▲/▼ → **Directory**.
2. Press **SELECT** → ▲/▼ → **Add contact**
3. Press **SELECT** → Enter number.
 - Press ▲/▼ – move the cursor to the left or right.
 - Press **DELETE** / **BACKSP** – erase a digit.
 - Press and hold **DELETE** – erase all digits.
 - Press and hold **PAUSE** – enter a dialing pause (a **P** appears).
4. Press **NEXT** to move on to the name.
5. Enter the name.
 - Press ▲/▼ – move the cursor to the left or right.
 - Press **0** – add a space.
 - Press **DELETE** / **BACKSP** – erase a character.
 - Press and hold **DELETE** – erase all characters.
6. Press **SAVE**.

7.2 Add a Predialled/Redial List Number to the Directory

You can save a predialled number or redial list number to the directory.

1. Enter a number. Press **SAVE**.
 - Press ▲/▼ – move the cursor to the left or right.
 - Press **DELETE** / **BACKSP** – erase a digit.
 - Press and hold **DELETE** – erase all digits.
 - Press and hold **PAUSE** – enter a dialing pause (a **P** appears).
2. Press **NEXT**.
3. Enter the name.
 - Press ▲/▼ – move the cursor to the left or right.
 - Press **0** – add a space.
 - Press **DELETE** / **BACKSP** – erase a character.
 - Press and hold **DELETE** – erase all characters.
4. Press **SAVE**.

7.3 View the Directory

Entries are sorted alphabetically.

Directory entries appear alphabetically.

1. Press .
2. Press ▲/▼.

-OR-

1. Press **MENU** → ▲/▼ → **Directory**
2. Press **SELECT** → **Review**.
3. Press **SELECT**.
4. Press ▲/▼.

7.4 Dial, Edit or Delete a Directory

7.4.1 Dial a Directory Entry

You can dial a directory entry on any line.

To dial a directory entry:

1. Search for the desired entry in the directory.
2. Press .

7.4.2 Edit a Directory Entry

1. Search for the desired entry in the directory.
2. Press **EDIT**. Edit the name.
 - Press **▲/▼** – move the cursor to the left or right.
 - Press **DELETE** or **BACKSP** – erase a digit.
 - Press and hold **DELETE** – erase all digits.
 - Press and hold **PAUSE** – enter a dialing pause (a **P** appears).
3. Press **NEXT**. Edit the number.
 - Press **▲/▼** – move the cursor to the left or right.
 - Press **DELETE** / **BACKSP** – erase a character.
 - Press and hold **DELETE** – erase all characters.
4. Press **SAVE**.

7.4.3 Delete a Directory Entry

To delete an entry:

1. Search for the desired entry in the directory.
2. Press **DELETE**.
3. Press **YES**.

NOTE

Once a directory entry is deleted, it cannot be retrieved.

7.5 Speed Dial

7.5.1 Assign a Speed Dial Directory Entry

You can assign 9 of your directory entries to a speed dial slot (**0, 2-9**). The speed dial entries are shared by all handsets.

Up to 9 speed dial entries can be stored. The speed dial number must be created from an existing entry in the directory.

1. Press **MENU** → ▲/▼ → **Directory**.
2. Press **SELECT** → ▲/▼ → **Speed dial**.
3. Press **SELECT** → ▲/▼ → (The desired speed dial location).
4. Press **ASSIGN**.
5. Press ▲/▼ → (The desired entry in the directory).
6. Press **ASSIGN**.

7.5.2 View the Speed Dial Directory

1. Press **MENU** → ▲/▼ → **Directory**.
2. Press **SELECT** → ▲/▼ → **Speed dial**.
3. Press **SELECT** → ▲/▼ .

7.5.3 Dial a Speed Dial Entry

When idle, press and hold the dialling key (**0, 2-9**) corresponding to the assigned entry you wish to call.

7.5.4 Reassign a Speed Dial Entry

1. Press **MENU** → ▲/▼ → **Directory**.
2. Press **SELECT** → ▲/▼ → **Speed dial**.
3. Press **SELECT** → ▲/▼ → (An occupied speed dial location).
4. Press **VIEW** → ▲/▼ (Th desired speed dial entry).
5. Press **REPLACE**.
6. Press **YES**.

7.5.5 Delete a Speed Dial Entry

1. Press **MENU** → ▲/▼ → **Directory**.
2. Press **SELECT** → ▲/▼ → **Speed dial**.
3. Press **SELECT** → ▲/▼ → (An occupied speed dial location).
4. Press **DELETE** / **DELETE**.
5. Press **YES**.

NOTE:

Deleting speed dial entries does not affect the directory entries

8. CALLER ID LOG

8.1 Caller ID

If you have subscribed to Caller ID service, you will be able to see your caller's number on your handset display (provided it is not blocked) prior to answering the call. If your caller's name is stored in the directory and a number match is found, you will see the caller's name on the display instead.

Your phone can store up to 50 answered calls and unanswered with date/time information in the caller ID log.

NOTE

If the phone number has more than 24 digits, it will not be saved or shown in the caller ID log.

Missed calls are marked with **XX Missed call(s)**. Each time you review a caller ID log entry marked with **NEW**, the number of missed calls decreases by one. When you have reviewed all the missed calls, the missed calls indicator no longer shows. You can review, redial, and copy an entry into the directory. Entries appear in reverse chronological order.

8.1.1 View the Caller ID Log

Review the calling number display history to find out who called, to easily return a call, or to copy the caller's name and number into your directory. **Caller ID log empty** appears if there are no records in the caller ID log.

1. Press **CID**.
2. Press **▲/▼**.

-OR-

1. Press **MENU** → **▲/▼** → **Caller ID log**
2. Press **SELECT** → **Review**.
3. Press **SELECT**.
4. Press **▲/▼**.

NOTE

Only one handset can review the calling number display history at a time. If another handset tries to enter the directory or calling number display history, it shows **Not available at this time**.

8.1.2 Dial a Caller ID Log Entry

1. Search for the desired entry in the caller ID log.
2. Press **TALK** / .

8.1.3 Save a Caller ID Log Entry to the Directory

Caller ID log entries can only be saved to the **Home** directory.

1. Select a desired entry in the caller ID log.
2. Press **SAVE**. Edit the number.
 - Press **▲/▼** – move the cursor to the left or right.
 - Press **DELETE** / **BACKSP** – backspace and erase a digit.
 - Press and hold **DELETE** – erase the entire entry.
 - Press and hold **PAUSE** – insert a dialing pause (a **P** appears).
3. Press **NEXT**. Edit the name.
 - Press **▲/▼** – move the cursor to the left or right.
 - Press **DELETE** / **BACKSP** – erase a character.
 - Press and hold **DELETE** – erase all characters.
4. Press **SAVE**.

NOTES

- When you try to save a caller ID log entry without any calling number display information, the handset displays **Unable to save**.
- When you try to save a number already stored in the directory, the screen shows **Number already saved**.

8.1.4 Delete a Single Entry in the Caller ID Log

1. Select a desired entry in the caller ID log.
2. Press **DELETE**.

8.1.5 Delete the Entire Caller ID Log

1. Press **MENU** → **▲/▼** → **Caller ID log**
2. Press **SELECT** → **▲/▼** → **Del all calls**.
3. Press **SELECT**.
4. Press **YES**.

8.1.6 Caller ID Log Screen Messages

Displays:	When:
Private name	The caller is blocking the name.
Private number	The caller is blocking the telephone number.
Private caller	The caller is blocking the name and number.
Unknown name	This caller's name is unavailable.
Unknown number	This caller's number is unavailable.
Unknown caller	No information is available about this caller.
Long distance or L (before the caller's number)	It is a long distance call.

9. ANSWERING MACHINE

Use the answering system menu of a cordless handset to turn on or off the answering system or message alert tone, set up the outgoing message, activate the call screening, or change the number of rings, remote access code or message recording time.

9.1 Answer On/Off

If you turn the answering system on, it answers calls and records messages only on the home line. If your paired mobile phone has voicemail, callers can leave messages with that voicemail service.

If your answering system is turned off and you change any of its settings, the answering system automatically turns on again and the handset displays **Calls will be answered**.

When the answering system is turned on, the **ANS ON** light on the telephone base is on and the handsets display **ANS ON**.

To turn the answering system on or off:

Press **ANS ON/OFF** on the telephone base to turn the answering system on or off. When the answering system is turned on, it announces, "Calls will be answered." The telephone base screen displays **Calls will be answered**. When the answering system is turned off, it announces, "Calls will not be answered." The telephone base screen displays **Calls will not be answered**.

OR

1. Press **MENU** → ▲/▼ → **AnsweringSys**
2. Press **SELECT** → ▲/▼ → **Answer ON/OFF**
3. Press **SELECT** → ▲/▼ → **On/ Off**
4. Press **SET**.

9.2 Outgoing Messages

An outgoing message is the greeting callers hear when calls are answered by the answering system.

9.2.1 Play Your Outgoing Messages

1. Press **MENU** → ▲/▼ → **AnsweringSys**
2. Press **SELECT** → **Announcement.**
3. Press **SELECT** → ▲/▼ → **Answer & record / Answer only.**
4. Press **SELECT.**
5. Press **PLAY.**

9.2.2 Record Your Own Outgoing Messages

You can record an outgoing message up to 90 seconds, but any outgoing message shorter than two seconds will not be recorded.

1. Press **MENU** → ▲/▼ → **AnsweringSys**
2. Press **SELECT** → **Announcement.**
3. Press **SELECT** → ▲/▼ → **Answer & record / Answer only.**
4. Press **SELECT.**
5. Press **RECORD.**
6. After the tone, speak towards the microphone.
7. Press **STOP.**

NOTES

- Your outgoing message can be up to 120 seconds in length.
- Outgoing messages shorter than two seconds are not recorded.

9.2.3 Delete Your Outgoing Messages

1. Press **MENU** → ▲/▼ → **AnsweringSys**
2. Press **SELECT** → **Announcement.**
3. Press **SELECT** → ▲/▼ → **Answer & record / Answer only.**
4. Press **SELECT.**
5. Press **PLAY.**
6. Press **RESET.**
7. Press **YES.**

9.3 Message Playback

If you have both new and old messages, you can play either new or old messages. The calling number display information displays on the screens when you play messages and you can call back the caller.

To listen to messages with the telephone base:

- Press ►/■/PLAY when the phone is not in use.

Options during playback:

- Press VOL- / VOL+ – adjust the message playback volume.
- Press ►►/SKIP – skip to the next message.
- Press ◀◀/REPEAT – repeat the message.
Press ◀◀/REPEAT twice – listen to the previous message.
- Press X/DELETE – delete the playing message.
- Press ►/■/STOP – stop the playback.

To listen to messages with a handset:

1. Press MENU → Play msgs.
2. Press SELECT.

If you have either new or old messages, the messages play automatically. If you have both new and old messages:

- To play new messages, press SELECT.
- To play old messages, press ▲/▼ → Play old msgs → SELECT.

Options during playback:

- Press VOL+ / VOL- – adjust the message playback volume.
- Press SKIP – skip to the next message.
- Press REPEAT – repeat the message.
Press REPEAT twice – hear the previous message.
- Press  – switch between the speakerphone and the handset earpiece.
- Press DELETE – delete the playing message.
- Press OFF – stop the playback.

NOTE

Only one device can access the answering system at a time.

9.4 Delete All Old Messages

Using the telephone base:

1. Press **X/DELETE**.
2. Press **X/DELETE** again.

Using a handset or the telephone base:

1. Press **MENU** → ▲/▼ → **AnsweringSys**
2. Press **SELECT** → ▲/▼ → **Delete all old**
3. Press **SELECT**
4. Press **YES**.

NOTE

You can only delete old messages, which are messages you have previously reviewed.

9.5 Record and Play Memos

Memos are messages you record as reminders for yourself or others using the same answering system. You can record your own memos using a system handset or the base. Play and delete them the same way as incoming messages.

To record a memo:

1. Press **MENU** → ▲/▼ → **AnsweringSys**
2. Press **SELECT** → ▲/▼ → **Record memo**.
3. Press **SELECT**.
4. After the tone, speak towards the microphone.
5. Press **STOP** to stop recording.

NOTES

- The system announces “Memory is full,” if you attempt to record a memo when the memory is full.
- Each memo can be up to 4 minutes in length.
- Memos shorter than 2 seconds are not recorded.

9.6 Answering Machine Settings

in the answering system setup menu, you can change the settings for answer mode, call screening, number of rings, remote access code, message alert tone and recording time.



9.7 Call Screening

By default, the answer machine is set in **Answer & Record** mode which allows callers to leave a message. This mode can be changed to **Answer only** which does not allow callers to leave a message. In that case, your callers will be prompted to call back later.

To turn call screening on or off:

1. Press **MENU** → ▲/▼ → **AnsweringSys**
2. Press **SELECT** → ▲/▼ → **Ans sys setup.**
3. Press **SELECT** → **Answer mode.**
4. Press **SELECT** → ▲/▼ → **Answer & Record / Answer only.**
5. Press **SELECT.**

9.8 Call Screening

The call screening feature lets you listen at the telephone base to a caller leaving a message. While monitoring an incoming message, you can answer the call by pressing  or  on the handset.

To turn call screening on or off:

1. Press **MENU** → ▲/▼ → **AnsweringSys**
2. Press **SELECT** → ▲/▼ → **Ans sys setup.**
3. Press **SELECT** → ▲/▼ → **Call screening.**
4. Press **SELECT** → ▲/▼ → **On / Off.**
5. Press **SET.**

9.9 Number of Rings

When the answering system is turned on, it answers all incoming home calls after the number of rings set. You can choose from 2, 3, 4, 5, or 6 rings; or time saver. With time saver selected, the answering system answers after 2 rings when you have new messages, and after 4 rings when you have no new messages. This enables you to check for new messages and avoid paying unnecessary long distance charges if you are calling from out of your local area.

To set the number of rings:

1. Press **MENU** → ▲/▼ → **AnsweringSys**
2. Press **SELECT** → ▲/▼ → **Ans sys setup**.
3. Press **SELECT** → ▲/▼ → **# of rings**.
4. Press **SELECT** → ▲/▼ → (The desired number of rings).
5. Press **SET**.

NOTE

If you set the number of rings for the answering system as 2 or 3 rings, the Caller ID Announce feature may not have enough time to announce the caller's full information.

9.10 Remote Access Code

A 2-digit security code is required to access the answering system remotely from any touch-tone telephone. The preset code is **00**. You can change the code to any number from **00** to **99**.

To change the remote access code:

1. Press **MENU** → ▲/▼ → **AnsweringSys**
2. Press **SELECT** → ▲/▼ → **Ans sys setup**.
3. Press **SELECT** → ▲/▼ → **Remote code**.
4. Press **SELECT**.
5. Enter the 2-digit number (default: **0000**)
6. Use the dialing keys to enter a two-digit number.
 - Press ▲/▼ – move the cursor to the left or right.
 - Press **DELETE** – **BACKSP** to erase a digit.
 - Press and hold **DELETE** – erase all digits.
7. Press **SAVE**.

9.11 Message Alert Tone

When the message alert tone is set to **On**, the telephone base beeps every 10 seconds to alert you to new messages. The tone stops when all new messages have been reviewed.

To change the setting:

1. Press **MENU** → ▲/▼ → **AnsweringSys**
2. Press **SELECT** → ▲/▼ → **Ans sys setup.**
3. Press **SELECT** → ▲/▼ → **Msg alert tone.**
4. Press **SELECT** → ▲/▼ → **On / Off.**
5. Press **SET.**

NOTES

- You cannot set the message alert tone when another handset or the telephone base is accessing the answering system.
- The message alert tone beeps only if all the conditions below are met.
 - > Answering system is on.
 - > Message alert tone setting is on.
 - > There are new messages.

9.11.1 Temporarily Turn Off the Message Alert Tone

If the message alert tone is turned on, the telephone base beeps every 10 seconds when there are new messages. Pressing any telephone base key (except **⏏/PAGE**) temporarily silences the message alert tone.

9.12 Recording Time

You can set the recording time limit for each incoming message.

To change the setting:

1. Press **MENU** → ▲/▼ → **AnsweringSys**
2. Press **SELECT** → ▲/▼ → **Ans sys setup.**
3. Press **SELECT** → ▲/▼ → **Recording time.**
4. Press **SELECT** → ▲/▼ → (The desired recording time).
5. Press **SET.**

9.13 Answering System and Voicemail

Your telephone has separate indicators for two different types of voice messages: those recorded on its built-in answering system and those recorded in your service provider's voicemail (fees may apply). Your telephone's built-in answering system messages and voicemail messages are separate. Each alerts you to new messages differently.

If **OO** and **XX New messages** display on the telephone base and handsets, there are new messages in the built-in answering system. To listen to messages recorded on your digital answering system, press **▶/■/PLAY/STOP** on the telephone base.

If **✉** and **New voicemail** display on telephone base and handsets, your telephone service provider is indicating that it has new voicemail for you. To listen to your voicemail, you typically dial an access number provided by your telephone service provider, followed by a security code or PIN.

Some service providers bundle or combine multiple services like voicemail and call waiting, so you may not be aware that you have voicemail. To check what services you have and how to access them, contact your telephone service provider.

To use your voicemail service rather than your answering system, turn off your answering system. To use your answering system rather than your voicemail service, contact your telephone service provider to deactivate your voicemail service.

9.13.1 Using the Answering System and Voicemail Together

You can also use your telephone answering system and voicemail together by setting your built-in answering system to answer before voicemail answers as described below. To learn how to program your voicemail settings, contact your telephone service provider. Then, if you are on a call, or if the answering system is busy recording a message and you receive another call, the second caller can leave a voicemail message.

Set your answering system to answer calls at least two rings earlier than your voicemail is set to answer. For example, if your voicemail answers after six rings, set your answering system to answer after four rings. Some voicemail providers may program the delay before answering calls in seconds instead of rings. In this case, allow six seconds per ring when determining the appropriate setting.

9.13.2 Message Capacity

The answering system can record and store up to 99 messages. Each message can be up to 3 minutes in length depending on the message length set. The total storage capacity for the outgoing messages and memos is approximately 15 minutes. The actual recording time depends on individual message characteristics. Messages remain available for replay until you delete them.

9.13.3 Voice Prompts

The system provides voice prompts to guide you through the setup procedures at the telephone base, message playback, remote access and recording outgoing messages.

9.13.4 Call Screening at the Telephone Base or Handset

To screen a call at the telephone base:

If the answering system and call screening are on, the outgoing messages and the incoming message broadcast at the telephone base while the call is answered by the answering system.

Options while a message is being recorded:

- Press **+VOL / VOL-** – adjust the call screening volume.
- Press **+VOL** – temporarily turn on the call screening if the call screening is set to off.
- Press **▶/■/PLAY/STOP** – temporarily turn on or off the call screening.

To screen a call at the handset

If the answering system is on and recording a message, press **SCREEN** to screen the call on your handset and the screen displays the caller ID information. If you do not subscribe to caller ID service, the handset shows **Incoming call**.



Options while a message is being recorded:

- Press **VOL-** or **VOL+** – adjust the call screening volume.
- Press **🔊** – switch between the speakerphone and the handset earpiece.

NOTE

The call screening setting on the base does not affect the call screening on the handset.

9.13.5 Call Intercept

When a caller is leaving a message on your answering system, you can stop recording and talk to the caller by pressing  /  on the handset.

9.14 Remote Access

You can access the answering system remotely by dialling your home telephone number from any touch-tone telephone.

9.14.1 Remotely Access the Answering System

1. Dial your telephone number from any touch-tone telephone.
2. When the system plays your outgoing messages, enter the 2-digit remote access code (**00** is the preset code).
3. You can also enter the remote commands (see **Remote commands** below).
4. Hang up or press 8 to end the call and save all undeleted messages.

9.14.2 Remote Commands

1	Press to listen to all messages.
2	Press to listen to new messages only.
3	Press to delete the current message (during playback).
33	Press twice to delete all old messages.
4	Press to repeat the current message (during playback).
5	Press to stop.
* 5	Press to listen to a list of remote commands.
6	Press to skip to the next message (during playback).
* 7	Press to record a new outgoing message.
8	Press to hang up the call.
0	Press to turn the answering system on or off.

NOTES

- If you do not press any keys after you enter the remote access code, all new messages play. If there are no new messages, all old messages play.
- Once the new messages have played, the telephone announces the help menu options. If you do not press any key within 20 seconds, the remote access call automatically disconnects.
- When the answering system is turned off, the telephone answers after 10 rings, and announces, "Please enter your remote access code."
- When the memory is full, the answering system answers incoming calls after 10 rings and announces, "Memory is full. Enter the remote access code."

10. TROUBLESHOOTING

If you have difficulty with your phone, please try the suggestion listed below.

Problem	Solutions
My telephone does not work at all.	<ul style="list-style-type: none">• Make sure the batteries are installed and charged correctly. For optimum daily performance, return the handset to the telephone base after use.• Make sure the power adapter is securely plugged into an outlet.• Make sure the telephone line cord is plugged firmly into the telephone base and the telephone wall jack.• Unplug the electrical power to the telephone base. Wait for approximately 15 seconds, then plug it back in. Allow up to one minute for the handset and telephone base to synchronize.• Remove and re-insert the batteries. If that still does not work, it might be necessary to purchase new batteries.• Disconnect the telephone base from the telephone wall jack and plug in a working telephone. If the other telephone does not work, the problem is probably in the wiring or the telephone service. Call your telephone service provider.
Low battery shows on screen.	<ul style="list-style-type: none">• Place the handset in the telephone base for recharging.• Remove and re-install the batteries and use it until fully depleted, then recharge the handset in the telephone base.• If the above measures do not solve the problem, replace the batteries.
The batteries do not charge in the handset or the handset batteries do not accept charge.	<ul style="list-style-type: none">• Make sure the handset is placed in the telephone base correctly.• Remove and reinstall the batteries, then charge for up to 16 hours.• Purchase new batteries.

There is interference during a telephone conversation. My calls fade out when I am using the handset.

- The handset may be out of range. Move it closer to the telephone base.
- If you subscribe to high-speed Internet service (digital subscriber line - DSL) through your telephone line, you must install a DSL filter between the telephone base and the telephone wall jack. The filter prevents noise and caller ID problems caused by DSL interference. Please contact your DSL service provider for more information about DSL filters.
- Appliances or other cordless telephones plugged into the same circuit as the telephone base can cause interference. Try moving the appliance or telephone base to another outlet.
- Other electronic products may cause interference to your cordless telephone. Install your telephone as far away as possible from the following electronic devices: wireless routers, radios, radio towers, pager towers, cellular telephones, digital telephones, intercoms, room monitors, televisions, VCRs, personal computers, kitchen appliances, and other cordless telephones.
- If your telephone is plugged in with a modem or a surge protector, plug the telephone (or modem/surge protector) into a different location. If this doesn't solve the problem, re-locate your telephone or modem farther apart from each other, or use a different surge protector.
- The location of your telephone base can impact the performance of your cordless phone. For better reception, install the telephone base in a centralized location within your home or office, away from walls or other obstructions. In many environments, elevating the telephone base improves overall performance.
- Disconnect the telephone base from the telephone wall jack and plug in a corded telephone. If calls are still not clear, the problem is probably in the wiring or telephone service. Contact your telephone service provider (charges might apply).
- If the other telephones in your home are having the same problem, the problem is in the wiring or telephone service. Contact your telephone service provider (charges may apply).

<p>There is no chime from the doorbell when it is pressed.</p>	<ul style="list-style-type: none"> • Make sure you install two AA batteries and connect AC power supply to the doorbell. • The doorbell light on the doorbell flashes when the doorbell is pressed. If the light doesn't flash, the doorbell may have run out of battery. You may need to replace new batteries. • Make sure the doorbell is registered to the telephone system. • Make sure your handset is in reception range and works probably. • Make sure the chime volume of your handset is not set to off. • If there is an incoming call when the doorbell is pressed, the handset will not respond to the chime. • When three or more system handsets are in use for a call at a time, video streaming will be disabled. • If you have more than one doorbell, make sure the other doorbell is not in use for video streaming. Only one doorbell can be used for video streaming at a time. • If the previous suggestions do not work, deregister all devices and register them to the telephone base again.
<p>Common cure for electronic equipment.</p>	<p>If the telephone is not responding normally, put the handset in the telephone base. If it does not respond, try the following (in the order listed):</p> <ul style="list-style-type: none"> • Disconnect the power to the telephone base. • Disconnect the batteries on the handset. • Wait a few minutes before connecting power to the telephone base. • Re-install the batteries and place the handset in the telephone base. • Wait for the handset to synchronize with the telephone base. Allow up to one minute for this to take place.

This telephone is not equipped with a grounding function. Therefore, some of the functions may be limited when used in PBX systems. Please contact the technical support of the network provider for further information.

11. WARRANTY

Vtech Product Warranty

Dear Customer, Thank you for purchasing a VTech telephone. For the product warranty applicable to this product, we refer you to the VTech website **www.euphones.vtech.com** for on line registration. Your retailer will provide you with a statutory 2-year warranty. If you have a problem within the first 2 years from purchase, call the warranty helpline or email them.

For Extended Warranty

Please keep a copy of your proof of purchase; you will need this when presenting the product back to where you bought it from.

1. If you have a problem after 2 years of purchase, up to 5 years from purchase:
Within 30 days of purchase you need to have registered your device at **www.euphones.vtech.com**.
2. The following parts to your device are not covered by this extended warranty:
Batteries, Cables, Damage caused by pets, Damaged caused from being dropped, Water Damage, Sun Exposure Damage.

Thank You.

12. APPROVAL AND CONFORMITY

This analog telephone DECT complies with the basic requirements contained in the R&TTE Directive 1999/5/EC on radio equipment and telecommunications terminal equipment and is suitable for connection and operation in the member state indicated on the base station and/or packaging.

The declaration of conformity may be viewed at www.euphones.vtech.com.

The CE symbol confirms the conformity of the telephone and the above directive.



13. CARE AND MAINTENANCE

Take care of your telephone

- Your cordless telephone contains sophisticated electronic parts, so you must treat it with care.
- Avoid rough treatment.
- Place the handset down gently.
- Save the original packing materials to protect your telephone if you ever need to ship it.

Avoid water

- You can damage your telephone if it gets wet. Do not use the handset in the rain, or handle it with the wet hands. Do not install the telephone base near a sink, bathtub or shower.

Electrical storms

- Electrical storms can sometimes cause power surges harmful to electronic equipment. For your own safety, take caution when using electric appliances during storms.

Cleaning your telephone

- Your telephone has a durable plastic casing that should retain its luster for many years. Clean it only with a soft cloth slightly dampened with water or a mild soap.
- Do not use excess water or cleaning solvents of any kind.

NOTE

Remember that electrical appliances can cause serious injury if used when you are wet or standing in water. If the telephone base should fall into water. **DO NOT RETRIEVE IT UNTIL YOU UNPLUG THE POWER CORD AND TELEPHONE LINE CORDS FROM THE WALL.** Then pull the unit out by the unplugged cords.

CAUTION

**RISK OF EXPLOSION IF BATTERY IS REPLACED
BY AN INCORRECT TYPE.**

**DISPOSE OF USED BATTERIES ACCORDING
TO THE INSTRUCTIONS.**

VTECH TELECOMMUNICATIONS LTD.

A member of THE VTECH GROUP OF COMPANIES.

© 2015 VTech Telecommunications Ltd. All Rights Reserved. V1.0. 12/15.

vtech[®]