

# vtech®

User's manual



LS1400-B

[www.euphones.vtech.com](http://www.euphones.vtech.com)

# 1. IMPORTANT SAFETY INSTRUCTIONS

When using your telephone equipment, basic safety precautions should always be followed to reduce the risk of fire, electric shock and injury, including the following:

1. Read and understand all the instructions.
2. Follow all warnings and instructions marked on the product.
3. Unplug this product from the wall outlet before cleaning. Do not use liquid cleaners or aerosol cleaners. Use a damp cloth for cleaning.
4. Do not use this product near water (for example, near a bath tub, kitchen sink, swimming pool).
5. Do not expose the telephone to direct sunlight or extreme cold environment. Do not put the telephone close to heating sources such as radiators, cookers, etc.
6. Do not overload wall outlets and extension cords as this can result in the risk of fire or electric shock.
7. Unplug this product from the wall outlet and refer servicing to VTech/distributor under the following conditions:
  - When the power supply cord or plug is damaged or frayed.
  - If the product does not operate normally by following the operating instructions.
  - If the product has been dropped and the cabinet has been damaged.
  - If the product exhibits a distinct change in performance.
8. Avoid using a telephone (other than a cordless type) during an electrical storm. There may be a remote risk of electric shock from lightning.
9. Do not use the telephone to report a gas leak in the vicinity of the leak.
10. Use only the supplied NiMH (Nickel Metal Hydride) batteries! The operation periods for the handsets are only applicable with the default battery capacities.
11. The use of other battery types or non-rechargeable batteries/primary cells can be dangerous. These may cause interference and/or unit damages. The manufacturer will not be held liable for damage arising from such non-compliance.
12. Do not use third party charging bays. The batteries may be damaged.
13. Please note the correct polarity while inserting the batteries.
14. Battery should not be exposed to excessive heat such as bright sunshine or fire and immersed in water.

## DISPOSAL WARNING

1. When this crossed-out wheeled bin symbol is attached to a product, it means the product is covered by the European Directive 2002/96/EC.
2. All electrical and electronic products/battery should be disposed of separately from the municipal waste stream via designated collection facilities appointed by the government or the local authorities.
3. The correct disposal of your old appliance/battery will help prevent potential negative consequences for the environment and human health.



For more detailed information about disposal of your old appliance/battery, please contact your city office, waste disposal service or the shop where you purchased the product.

If you have questions about this product, or having difficulty with setup or operation, contact our Customer Service Centre.

## POWER ADAPTOR INFORMATION

**Power adaptor** VTech (Qingyuan) Plastics & Electronics Co. Ltd. -  
Model: VT04EEU06045, Input: 100-240V AC 50/60Hz 150mA,  
Output: 6VDC 450mA (EU plug).

**Battery** AAx2, Ni-MH, 400mAh.

For pluggable equipment, the socket outlet shall be installed near the equipment and shall be easily accessible.

## 2. SET UP THE TELEPHONE

### 2.1 Package Contents

The package contains the following items:

- 1 Handset
- 1 Base station
- 1 Power adaptor for base station
- 1 Telephone line cord
- 2 AAA NiMH rechargeable batteries
- 1 User's manual

### 2.2 Connect the Base

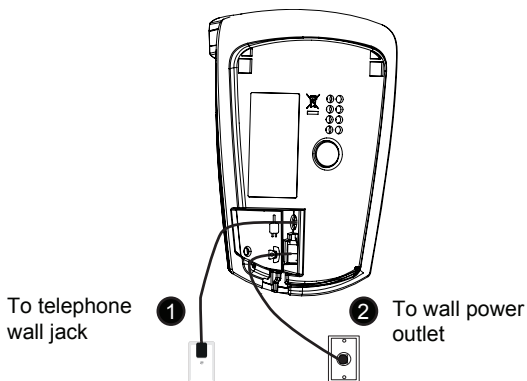

#### **NOTE**

- Use only the supplied power adaptor.

## 2.3 Install and Charge the Handset Battery

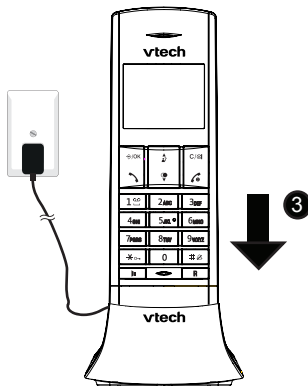
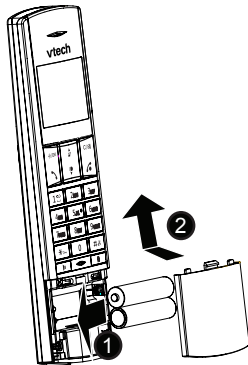

### NOTES

- Use only the supplied AAx2, Ni-MH, 400mAh batteries.
- If you do not use the handset for a long time, disconnect and remove the battery to prevent possible leakage.

# 3. GET TO KNOW YOUR PHONE

## 3.1 Overview of the Handset

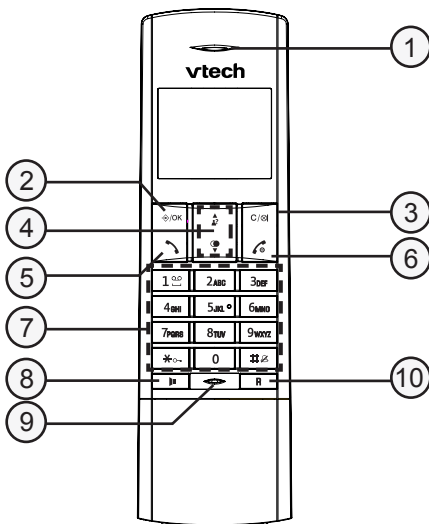

1. EARPIECE
2. ↵/OK MENU / OK
3. C/⊗ MUTE / DELETE / INTERCOM
4. ▲ UP / CALL LIST / VOLUME UP  
● DOWN / REDIAL LIST / VOLUME DOWN
5. ↶ TALK ON / RECALL(FLASH)
6. ↷ TALK OFF / CANCEL / BACK
7. ALPHANUMERIC KEYPAD, \*↵ (STAR), #⊗ (HASH)
8. ▶ SPEAKERPHONE
9. MICROPHONE
10. R RECALL

## 3.2 Overview of the Base Station

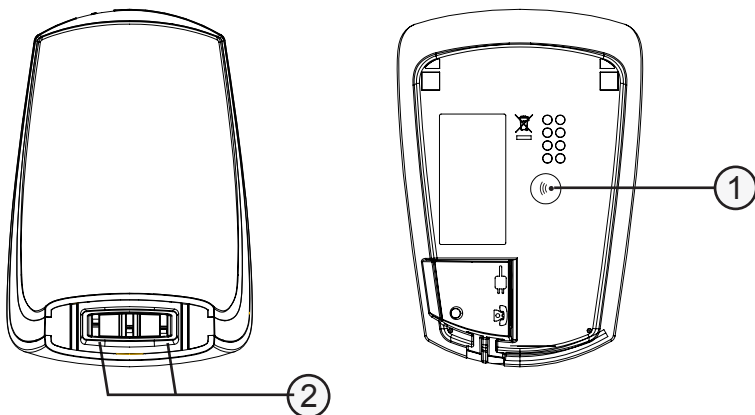

### 1. **•••) PAGE**

Press to page all registered handset(s). Handset(s) will ring for approximately 60 seconds.

Press and hold for 5 seconds to enter the registration mode.

### 2. **CHARGING CRADLE**

For charging the handset.

### 3.3 Handset LCD display icons and symbols

The LCD display gives you information on the current status of the telephone.

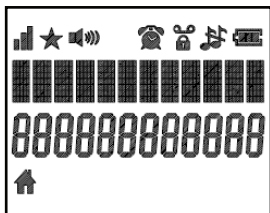

Display icons	Icons can be Steadily On (visible), Flashing or Off (not visible)
	Scroll up / down the menu items / Phonebook list / Redial list / Call List.
	Steadily on when the handset is with reception range. Flashes when out of range or not registered to the base.
	Steadily on when a call is in progress.
	Steadily on when the ringer is switched off.
	Steadily on when an alarm is set. Flashes when the alarm time set before reaches.
	Steadily on when the keypad is locked.
	Steadily on when a message is received at the telephone service provider.
	Steadily on when the battery is fully charged. Whole icon flashes when the battery is charging.
	Flashes when low battery power level is detected and the handset needs charging.
	Steadily on when when you have received missed calls.
	Steadily on when the speakerphone is turned on.



### 3.4 Menu Navigation

In idle mode:

1. Press ⇨/OK.
2. ▲/▼ to scroll to a menu option.
3. Press ⇨/OK to select.

**-OR-**

Press **C/⊗** to return to previous screen.

**-OR-**

press and hold **C/⊗** to return to idle mode.

CALL LIST	PHONEBOOK	BS SETTINGS
Review Call List Under a selected Call List entry: DETAILS ADD TO PB DELETE DELETE ALL CATEGORY	Under a selected Phonebook entry: ADD VIEW EDIT DELETE DELETE ALL PB STATUS	DELETE HS DIAL MODE FLASH TIME CHANGE PIN

HS SETTINGS	REGISTRATION	DEFAULT
ALARM RING SETUP TONE SETUP LANGUAGE RENAME HS AUTO ANSWER DATE & TIME	PIN?	PIN?

## 4. USE YOUR PHONE

### 4.1 Switch On/Off the Handset

Press and hold .

### 4.2 Make a Call

Enter phone number. Press .

### 4.3 Answer an Incoming Call

Press .

**-OR-**

If **AUTO ANSWER** is **ON**:

Lift the handset.

### 4.4 Adjust Listening Volume During a Call

To adjust listening volume during a call:

Press .

### 4.5 Mute/unmute a Call (Microphone Off/On)

To mute or end mute the microphone during a call:

Press **C**/.

### 4.6 End a Call

Press .

**-OR-**

Place the handset on the base.

### 4.7 Turn the Handset Ringer On/Off



Press and hold .

### 4.8 Turn the Keypad Lock On/Off

Press and hold .

## 4.9 Redial









### 4.9.1 Redial a Number from the Redial List

1. Press .
2.  → (a desired entry).
3. Press  / .





#### **NOTE**

If there is no number in the list, the display shows “EMPTY”.





### 4.9.2 Store a Redial Number into the Phonebook

1. Press .
2.  → (a desired entry).
3. Press  / OK →  → **ADD TO PB.**
4. Press  / OK → Enter name.
5. Press  / OK → Enter number.
6. Press  / OK →  → **MELODY 1 - MELODY 10.**
7. Press  / OK.





### 4.9.3 Delete a Redial Number

1. Press .
2.  → (a desired entry).
3. Press  / OK →  → **DELETE.**
4. Press  / OK.

### 4.9.4 Delete All Redial Numbers

1. Press .
2. Press  / OK →  → **DELETE ALL.**
3. Press  / OK twice.

## 4.10 Find the Handset (PAGING)

1. Press  on the base.
2. Press  /  /  on handset, or press  on the base to stop paging.

## 5. PHONEBOOK

### 5.1 Store a Number Entry in the Phonebook

1. Press /OK → / → **PHONEBOOK**. Press /OK.

#### **NOTE**

If there is no entry in the list, the display shows “**EMPTY**”.

2. Press /OK → / → **ADD**.
3. Press /OK → Enter name.
4. Press /OK → Enter number.
5. Press /OK → / → **MELODY 1 - MELODY 10**.
6. Press /OK.

### 5.2 Dial an Entry

1. Press /OK → / → **PHONEBOOK**. Press /OK
2. / → (a desired entry).
3. Press / to dial out.

### 5.3 Edit a Phonebook Entry

1. Press /OK → / → **PHONEBOOK**. Press /OK
2. / → (a desired entry).
3. Press /OK → / → **EDIT**.
4. Press /OK → Enter name.
5. Press /OK → Enter number.
6. Press /OK → / → **MELODY 1 - MELODY 10**.
7. Press /OK.

### 5.4 Delete a Phonebook Entry

1. Press /OK → / → **PHONEBOOK**. Press /OK
2. / → (a desired entry).
3. Press /OK → / → **DELETE**.
4. Press /OK.

## 5.5 Delete All Phonebook Entries

1. Press  $\diamond$ /OK  $\rightarrow$   $\blacktriangle$ / $\blacktriangledown$   $\rightarrow$  **PHONEBOOK**. Press  $\diamond$ /OK
2.  $\blacktriangle$ / $\blacktriangledown$   $\rightarrow$  (a desired entry).
3. Press  $\diamond$ /OK twice  $\rightarrow$   $\blacktriangle$ / $\blacktriangledown$   $\rightarrow$  **DELETE ALL**.
4. Press  $\diamond$ /OK twice.

## 5.6 Check Number of Phonebook Entry Used

You can check how many entries have been occupied in your phone and how many phonebook entries are available for you to store in the phonebook.

1. Press  $\diamond$ /OK  $\rightarrow$   $\blacktriangle$ / $\blacktriangledown$   $\rightarrow$  **PHONEBOOK**. Press  $\diamond$ /OK
2. Press  $\diamond$ /OK  $\rightarrow$   $\blacktriangle$ / $\blacktriangledown$   $\rightarrow$  **PB STATUS**.
3. Press  $\diamond$ /OK

## 6. PHONE SETTINGS

Your phone comes with a selection of settings that you can change to personalize your phone the way you like it to work.

### 6.1 Date and Time Settings

You will need to set the correct time and date so that you know when you received answering machine (applicable to model with answering machine) or call list entries.

#### 6.1.1 Set the Date Format

1. Press  $\Rightarrow$ /OK  $\rightarrow$   $\blacktriangle$ / $\blacktriangledown$   $\rightarrow$  **HS SETTINGS.**
2. Press  $\Rightarrow$ /OK  $\rightarrow$   $\blacktriangle$ / $\blacktriangledown$   $\rightarrow$  **DATE & TIME.**
3. Press  $\Rightarrow$ /OK  $\rightarrow$   $\blacktriangle$ / $\blacktriangledown$   $\rightarrow$  **DATE FORMAT.**
4. Press  $\Rightarrow$ /OK  $\rightarrow$   $\blacktriangle$ / $\blacktriangledown$   $\rightarrow$  **DD-MM-YY / MM-DD-YY.**
5. Press  $\Rightarrow$ /OK.

#### 6.1.2 Set the Time

1. Press  $\Rightarrow$ /OK  $\rightarrow$   $\blacktriangle$ / $\blacktriangledown$   $\rightarrow$  **HS SETTINGS.**
2. Press  $\Rightarrow$ /OK  $\rightarrow$   $\blacktriangle$ / $\blacktriangledown$   $\rightarrow$  **DATE & TIME.**
3. Press  $\Rightarrow$ /OK  $\rightarrow$   $\blacktriangle$ / $\blacktriangledown$   $\rightarrow$  **SET TIME.**
4. Press  $\Rightarrow$ /OK  $\rightarrow$  Enter time.
5. Press  $\Rightarrow$ /OK  $\rightarrow$   $\blacktriangle$ / $\blacktriangledown$   $\rightarrow$  **AM or PM .**

#### 6.1.3 Set the Date

1. Press  $\Rightarrow$ /OK  $\rightarrow$   $\blacktriangle$ / $\blacktriangledown$   $\rightarrow$  **HS SETTINGS.**
2. Press  $\Rightarrow$ /OK  $\rightarrow$   $\blacktriangle$ / $\blacktriangledown$   $\rightarrow$  **DATE & TIME.**
3. Press  $\Rightarrow$ /OK  $\rightarrow$   $\blacktriangle$ / $\blacktriangledown$   $\rightarrow$  **SET DATE.**
4. Press  $\Rightarrow$ /OK  $\rightarrow$  Enter Year.
5. Press  $\Rightarrow$ /OK  $\rightarrow$  Enter Date.
6. Press  $\Rightarrow$ /OK.

## 6.2 Handset Settings

### 6.2.1 Alarm

1. Press ⇨/OK → ▲/▼ → **HS SETTINGS**.
2. Press ⇨/OK → ▲/▼ → **ALARM**.
3. Press ⇨/OK → ▲/▼ → **ON / OFF**.

If **ON** is selected:

1. Press ⇨/OK → Enter time.
2. Press ⇨/OK → **AM** or **PM** .
3. Press ⇨/OK. You will need to set the snooze function.
4. Press ⇨/OK → ▲/▼ → **ON / OFF**.
5. Press ⇨/OK.

### 6.2.2 Set the Ringer Melody for External Calls

1. Press ⇨/OK → ▲/▼ → **HS SETTINGS**.
2. Press ⇨/OK → ▲/▼ → **RING SETUP**.
3. Press ⇨/OK → ▲/▼ → **EXT. RING**.
4. Press ⇨/OK → ▲/▼ → **MELODY 1 - MELODY 10**.
5. Press ⇨/OK.

### 6.2.3 Set the Ringer Melody for Internal Calls

1. Press ⇨/OK → ▲/▼ → **HS SETTINGS**.
2. Press ⇨/OK → ▲/▼ → **RING SETUP**.
3. Press ⇨/OK → ▲/▼ → **INT. RING**.
4. Press ⇨/OK → ▲/▼ → **MELODY 1 - MELODY 10**.
5. Press ⇨/OK.

### 6.2.4 Set the Ringer Volume

1. Press ⇨/OK → ▲/▼ → **HS SETTINGS**.
2. Press ⇨/OK → ▲/▼ → **RING SETUP**.
3. Press ⇨/OK → ▲/▼ → **RING VOLUME**.
4. Press ⇨/OK → ▲/▼ → **VOLUME 1 - VOLUME 5, or VOLUME OFF**.
5. Press ⇨/OK.

### 6.2.5 Set Alert Tones

A single beep is emitted when you press a key. You can turn on or off the key tone. You can also turn on the alert tones when low battery and out of range are detected. Low battery tone will be emitted while you are talking with the phone to alert you that you need to charge your battery. Out of range tone will be emitted when the handset is out of range from the base.

1. Press  $\diamond$ /OK  $\rightarrow$   $\blacktriangle$ / $\blacktriangledown$   $\rightarrow$  **HS SETTINGS**.
2. Press  $\diamond$ /OK  $\rightarrow$   $\blacktriangle$ / $\blacktriangledown$   $\rightarrow$  **STONE SETUP**.
3. Press  $\diamond$ /OK  $\rightarrow$   $\blacktriangle$ / $\blacktriangledown$   $\rightarrow$  **KEY TONE / BATTERY TONE / OUT OF RANGE**.
4. Press  $\diamond$ /OK  $\rightarrow$   $\blacktriangle$ / $\blacktriangledown$   $\rightarrow$  **ON / OFF**.
5. Press  $\diamond$ /OK.

### 6.2.6 Set the Handset Language

1. Press  $\diamond$ /OK  $\rightarrow$   $\blacktriangle$ / $\blacktriangledown$   $\rightarrow$  **HS SETTINGS**.
2. Press  $\diamond$ /OK  $\rightarrow$   $\blacktriangle$ / $\blacktriangledown$   $\rightarrow$  **LANGUAGE**.
3. Press  $\diamond$ /OK  $\rightarrow$   $\blacktriangle$ / $\blacktriangledown$   $\rightarrow$  (The desired language).
4. Press  $\diamond$ /OK.

### 6.2.7 Rename the Handset

1. Press  $\diamond$ /OK  $\rightarrow$   $\blacktriangle$ / $\blacktriangledown$   $\rightarrow$  **HS SETTINGS**.
2. Press  $\diamond$ /OK  $\rightarrow$   $\blacktriangle$ / $\blacktriangledown$   $\rightarrow$  **RENAME HS**.
3. Press  $\diamond$ /OK  $\rightarrow$   $\blacktriangle$ / $\blacktriangledown$   $\rightarrow$  Enter name.
4. Press  $\diamond$ /OK.

### 6.2.8 Set the Auto Answer

1. Press  $\diamond$ /OK  $\rightarrow$   $\blacktriangle$ / $\blacktriangledown$   $\rightarrow$  **HS SETTINGS**.
2. Press  $\diamond$ /OK  $\rightarrow$   $\blacktriangle$ / $\blacktriangledown$   $\rightarrow$  **AUTO ANSWER**.
3. Press  $\diamond$ /OK  $\rightarrow$   $\blacktriangle$ / $\blacktriangledown$   $\rightarrow$  **ON / OFF**.
4. Press  $\diamond$ /OK.



## 6.3 Base Settings

### 6.3.1 Set the Dial Mode

The dial mode settings is country dependent. Please contact your local service provider for the correct settings.

1. Press  $\leftarrow$ /OK  $\rightarrow$   $\blacktriangle$ / $\blacktriangledown$   $\rightarrow$  **BS SETTINGS**.
2. Press  $\leftarrow$ /OK  $\rightarrow$   $\blacktriangle$ / $\blacktriangledown$   $\rightarrow$  **DIAL MODE**.
3. Press  $\leftarrow$ /OK  $\rightarrow$   $\blacktriangle$ / $\blacktriangledown$   $\rightarrow$  **TONE** or **PULSE**.
4. Press  $\leftarrow$ /OK.

### 6.3.2 Set the Flash Time

The flash time settings is country dependent. Please contact your local service provider for the correct settings.

1. Press  $\leftarrow$ /OK  $\rightarrow$   $\blacktriangle$ / $\blacktriangledown$   $\rightarrow$  **BS SETTINGS**.
2. Press  $\leftarrow$ /OK  $\rightarrow$   $\blacktriangle$ / $\blacktriangledown$   $\rightarrow$  **FLASH TIME**.
3. Press  $\leftarrow$ /OK  $\rightarrow$   $\blacktriangle$ / $\blacktriangledown$   $\rightarrow$  **SHORT / MEDIUM / LONG**.
4. Press  $\leftarrow$ /OK.

### 6.3.3 Change the System PIN Code

The default system PIN code is **0000**.

1. Press  $\leftarrow$ /OK  $\rightarrow$   $\blacktriangle$ / $\blacktriangledown$   $\rightarrow$  **BS SETTINGS**.
2. Press  $\leftarrow$ /OK  $\rightarrow$   $\blacktriangle$ / $\blacktriangledown$   $\rightarrow$  **CHANGE PIN**.
3. Press  $\leftarrow$ /OK.
4. Enter old **PIN** (Default: **0000**).
5. Press  $\leftarrow$ /OK  $\rightarrow$  Enter new **PIN**.
6. Press  $\leftarrow$ /OK  $\rightarrow$  Enter new **PIN** again.
7. Press  $\leftarrow$ /OK.

## 6.4 Reset Your Phone

You can reset your phone to the default settings. After reset, all settings and entries (except phonebook) will be deleted.













1. Press ⇨/OK → ▲/▼ → **DEFAULT**.
2. Press ⇨/OK → Enter old **PIN** (Default: **0000**).
3. Press ⇨/OK twice.

# 7. CALLER DISPLAY









## 7.1 Call List

This feature is available if you have subscribed to the Caller ID service from your local service provider telephone company.







## 7.2 Store a Call List Number into the Phonebook

1. Press  .
2. / → (a desired entry).
3. Press /OK → / → **ADD TO PB.**
4. Press /OK → Enter name.
5. Press /OK → Edit number.
6. Press /OK → / → **MELODY 1 - MELODY 10.**
7. Press.







## 7.3 Delete an Entry in the Call List

1. Press  .
2. / → (a desired entry).
3. Press /OK → / → **DELETE.**
4. Press /OK.

## 7.4 Delete All Call List Entries

1. Press  .
2. Press /OK → / → **DELETE ALL.**
3. Press /OK twice.

## 7.5 View the Details of the Call List Entry

1. Press  .
2. Press /OK → / → **DETAILS.**
3. Press /OK.

## 7.6 View Call List Entries by Categories

1. Press .
2. Press /OK → / → **CATEGORY**.
3. Press /OK → / → **ALL CALLS / MISSED CALLS**.
4. Press /OK.

## 8. TROUBLESHOOTING

Problem	Solutions
<b>My telephone does not work at all.</b>	<ul style="list-style-type: none"><li>• Make sure the batteries are installed and charged correctly. For optimum daily performance, return the handset to the telephone base after use.</li><li>• Remove and reinstall the batteries, then charge for up to 16 hours. If the problem isn't solved, purchase new batteries.</li><li>• Make sure the power adapter is securely plugged into an outlet not controlled by a wall switch.</li><li>• Make sure the telephone line cord is plugged firmly into the telephone base and the telephone wall jack.</li></ul>
<b>Common cure for electronic equipment.</b>	<p>If the telephone is not responding normally, put the handset in the telephone base. If it does not respond, try the following (in the order listed):</p> <ul style="list-style-type: none"><li>• Disconnect the power to the telephone base.</li><li>• Disconnect the batteries on the handset.</li><li>• Wait a few minutes before connecting power to the telephone base.</li><li>• Re-install the batteries and place the handset in the telephone base.</li><li>• Wait for the handset to synchronize with the telephone base. Allow up to one minute for this to take place.</li></ul>

**There is interference during a telephone conversation. My calls fade out when I am using the handset.**

- The handset may be out of range. Move it closer to the telephone base.
- If you subscribe to high-speed Internet service (digital subscriber line - DSL) through your telephone line, you must install a DSL filter between the telephone base and the telephone wall jack. The filter prevents noise and caller ID problems caused by DSL interference. Please contact your DSL service provider for more information about DSL filters.
- Appliances or other cordless telephones plugged into the same circuit as the telephone base can cause interference. Try moving the appliance or telephone base to another outlet.
- Other electronic products may cause interference to your cordless telephone. Install your telephone as far away as possible from the following electronic devices: wireless routers, radios, radio towers, pager towers, cellular telephones, digital telephones, intercoms, room monitors, televisions, VCRs, personal computers, kitchen appliances, and other cordless telephones.
- If your telephone is plugged in with a modem or a surge protector, plug the telephone (or modem/surge protector) into a different location. If this doesn't solve the problem, re-locate your telephone or modem farther apart from each other, or use a different surge protector.
- The location of your telephone base can impact the performance of your cordless phone. For better reception, install the telephone base in a centralized location within your home or office, away from walls or other obstructions. In many environments, elevating the telephone base improves overall performance.
- Disconnect the telephone base from the telephone wall jack and plug in a corded telephone. If calls are still not clear, the problem is probably in the wiring or telephone service. Contact your telephone service provider (charges might apply).
- If the other telephones in your home are having the same problem, the problem is in the wiring or telephone service. Contact your telephone service provider (charges may apply).

**Common cure for electronic equipment.**

If the telephone is not responding normally, put the handset in the telephone base. If it does not respond, try the following (in the order listed):

- Disconnect the power to the telephone base.
- Disconnect the batteries on the handset.
- Wait a few minutes before connecting power to the telephone base.
- Re-install the batteries and place the handset in the telephone base.
- Wait for the handset to synchronize with the telephone base. Allow up to one minute for this to take place.

This telephone is not equipped with a grounding function. Therefore, some of the functions may be limited when used in PBX systems. Please contact the technical support of the network provider for further information.

## 9. WARRANTY

### Vtech Product Warranty

Dear Customer, Thank you for purchasing a VTech telephone. For the product warranty applicable to this product, we refer you to the VTech website **[www.euphones.vtech.com](http://www.euphones.vtech.com)** for on line registration. Your retailer will provide you with a statutory 2-year warranty. If you have a problem within the first 2 years from purchase, call the warranty helpline or email them.

### For Extended Warranty

Please keep a copy of your proof of purchase; you will need this when presenting the product back to where you bought it from.

1. If you have a problem after 2 years of purchase, up to 5 years from purchase: Within 30 days of purchase you need to have registered your device at **[www.euphones.vtech.com](http://www.euphones.vtech.com)**.
2. The following parts to your device are not covered by this extended warranty: Batteries, Cables, Damage caused by pets, Damaged caused from being dropped, Water Damage, Sun Exposure Damage.

Thank You.



## 10. APPROVAL AND CONFORMITY

This analog telephone DECT complies with the basic requirements contained in the R&TTE Directive 1999/5/EC on radio equipment and telecommunications terminal equipment and is suitable for connection and operation in the member state indicated on the base station and/or packaging.

The declaration of conformity may be viewed at [www.euphones.vtech.com](http://www.euphones.vtech.com).

The CE symbol confirms the conformity of the telephone and the above directive.



# 11. CARE AND MAINTENANCE INSTRUCTIONS

## Take care of your telephone

- Your cordless telephone contains sophisticated electronic parts, so you must treat it with care.
- Avoid rough treatment.
- Place the handset down gently.
- Save the original packing materials to protect your telephone if you ever need to ship it.

## Avoid water

- You can damage your telephone if it gets wet. Do not use the handset in the rain, or handle it with wet hands. Do not install the telephone base near a sink, bathtub or shower.

## Electrical storms

- Electrical storms can sometimes cause power surges harmful to electronic equipment. For your own safety, take caution when using electric appliances during storms.

## Cleaning your telephone

- Your telephone has a durable plastic casing that should retain its luster for many years. Clean it only with a soft cloth slightly dampened with water or a mild soap.
- Do not use excess water or cleaning solvents of any kind.

## NOTE

Remember that electrical appliances can cause serious injury if used when you are wet or standing in water. If the telephone base should fall into water, **DO NOT RETRIEVE IT UNTIL YOU UNPLUG THE POWER CORD AND TELEPHONE LINE CORDS FROM THE WALL.** Then pull the unit out by the unplugged cords.

## CAUTION

**RISK OF EXPLOSION IF BATTERY IS REPLACED BY AN INCORRECT TYPE.**

**DISPOSE OF USED BATTERY ACCORDING TO THE INSTRUCTIONS.**

**VTECH TELECOMMUNICATIONS LTD.**

**A member of THE VTECH GROUP OF COMPANIES.**

© 2015 VTech Telecommunications Ltd. All Rights Reserved. V1.0. 12/15.

**vtech<sup>®</sup>**